

90mm 90mm

MRA505X-12G
5x3.5"SATA/SAS 12G HDD Enclosure

120mm

MRA505-12G: 硬盘仓带独立电源开关
MRA505N-12G: 硬盘仓无独立电源开关

说明书 | User Manual

目录
Table of Contents

中文

产品介绍 01-03
安装步骤 04
插入硬盘 05
退出硬盘 06
产品功能说明 07-08
注意事项 09

ENGLISH

Introduction 10-12
Installation 13
Inserting Hard Drive 14
Removing Hard Drive 15
How to use 16-17
Cautions 18

目录
Table of Contents

中文

产品介绍 01-03
安装步骤 04
插入硬盘 05
退出硬盘 06
产品功能说明 07-08
注意事项 09

ENGLISH

Introduction 10-12
Installation 13
Inserting Hard Drive 14
Removing Hard Drive 15
How to use 16-17
Cautions 18

产品介绍

MRA505X-12G 3.5寸5盘位SATA/SAS硬盘抽取盒是一款占用三个5.25寸光驱位空间,可容纳5颗3.5寸硬盘的存储扩展产品;产品内外采用金属材料,坚固耐用;免工具抽取设计,实现快速更换硬盘;带独立电源开关,8公分风扇配合智能温控主动散热;硬盘仓门带锁,保护硬盘使用安全;这是一款可应用于严峻环境、高性能、高稳定性要求的存储产品。

产品规格

- 传输介质: SATA
- 支持硬盘: 3.5寸 SATA 6Gbps/SAS 12Gbps 硬盘
- 产品材质: 铝合金外壳和轨道、PC塑胶门、钢板后盖
- 应用系统: Windows, Mac
- 指示灯: 硬盘电源灯、读写灯、风扇故障、温度超限
- 产品尺寸: 215(L)x146(W)x127.5(H)mm
- 工作温度: 0~55°C

包装内容

MRA505X-12G产品	1 pcs
硬盘仓钥匙	2 pcs
SATA数据线	5 pcs
说明书	1 pcs
机箱固定螺丝	8 pcs

[01]

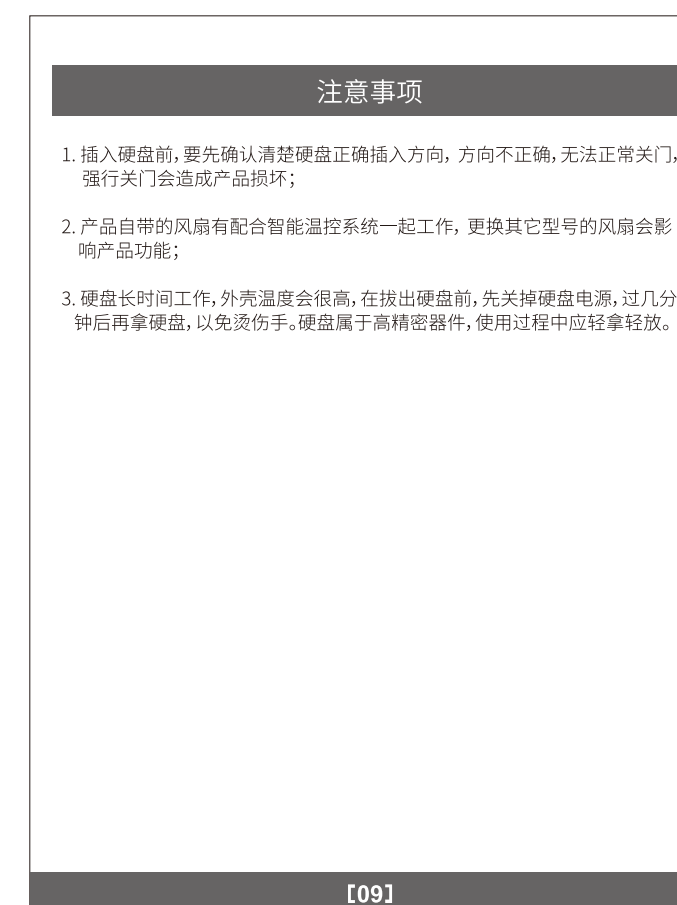
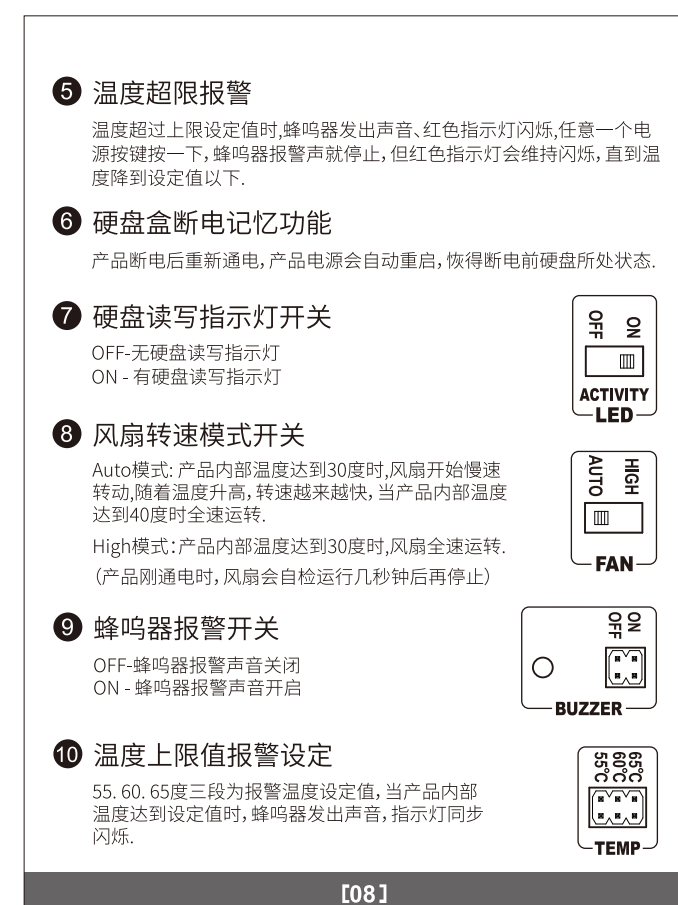
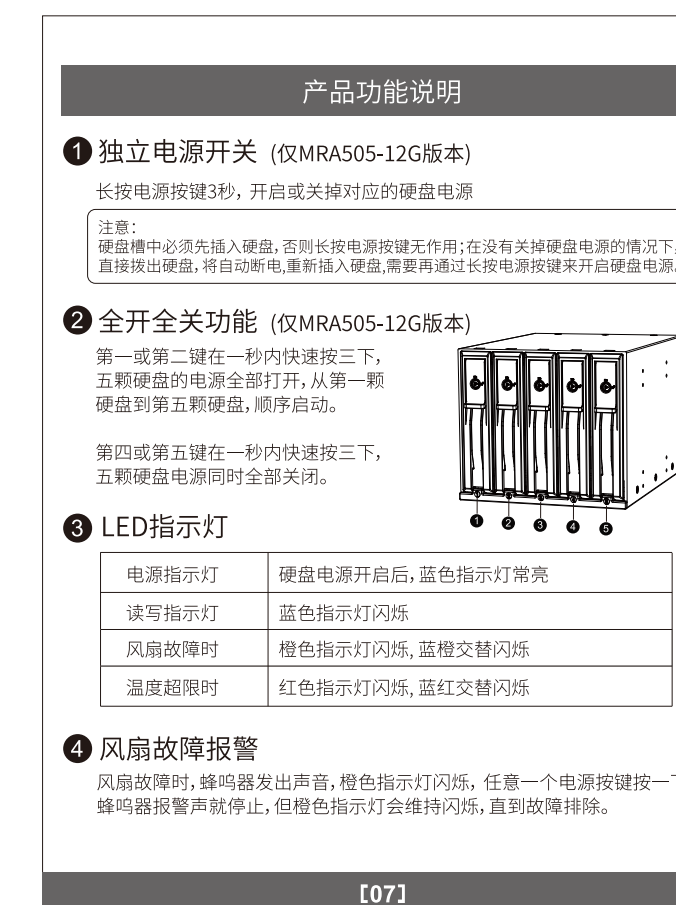
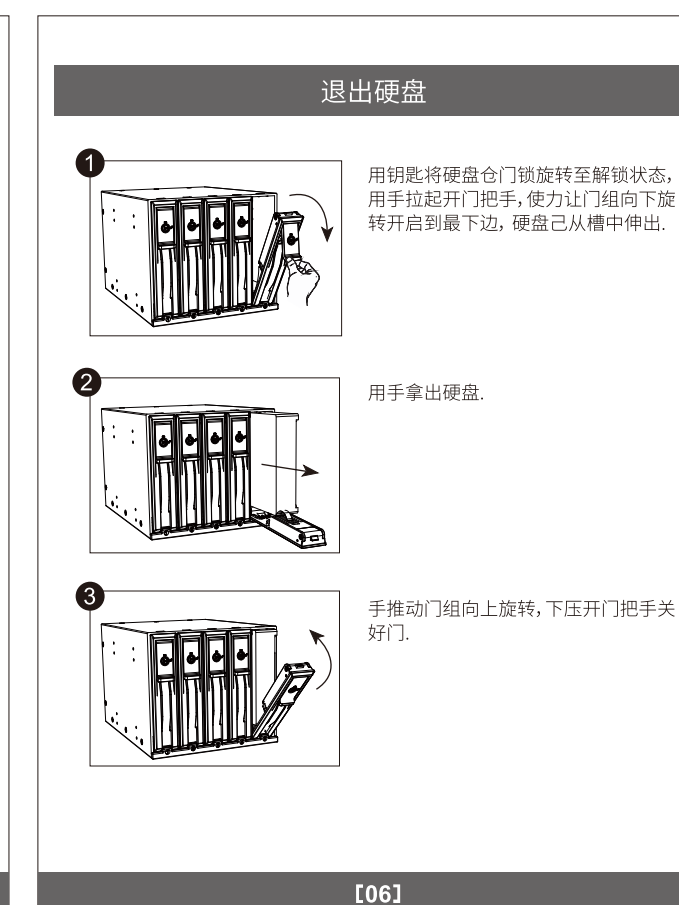
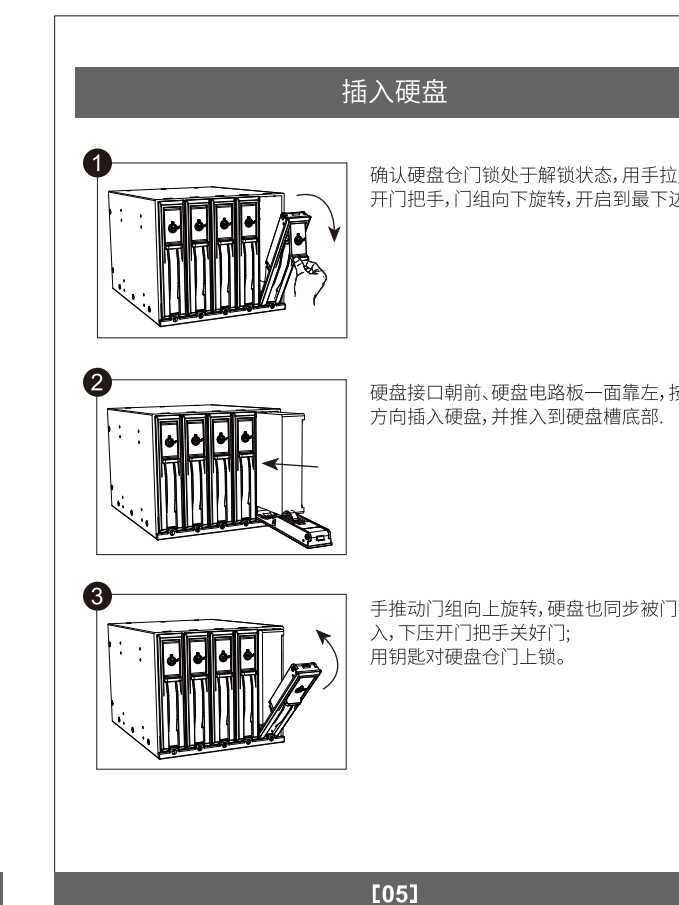
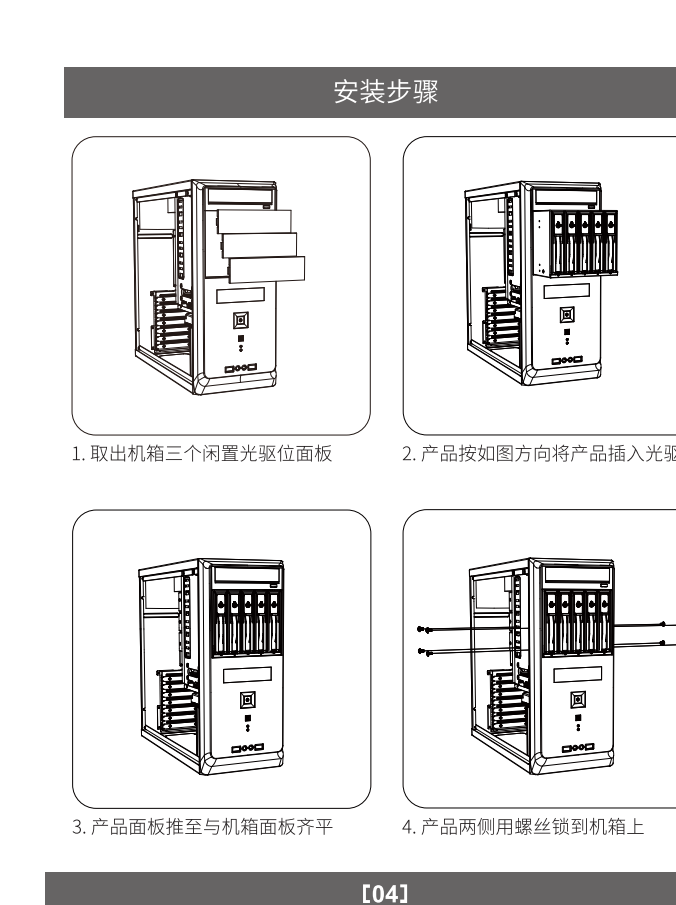
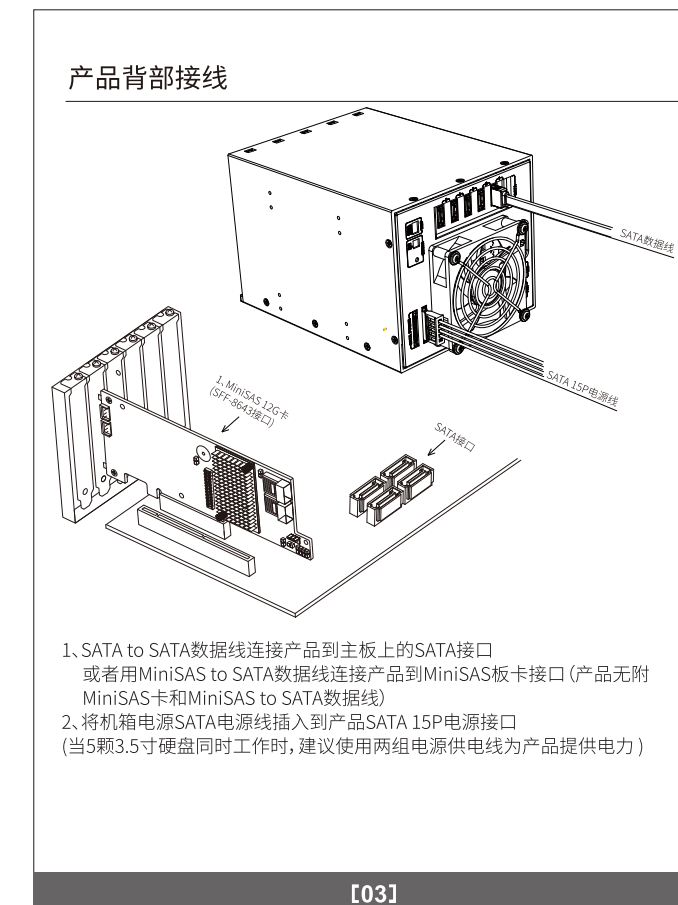
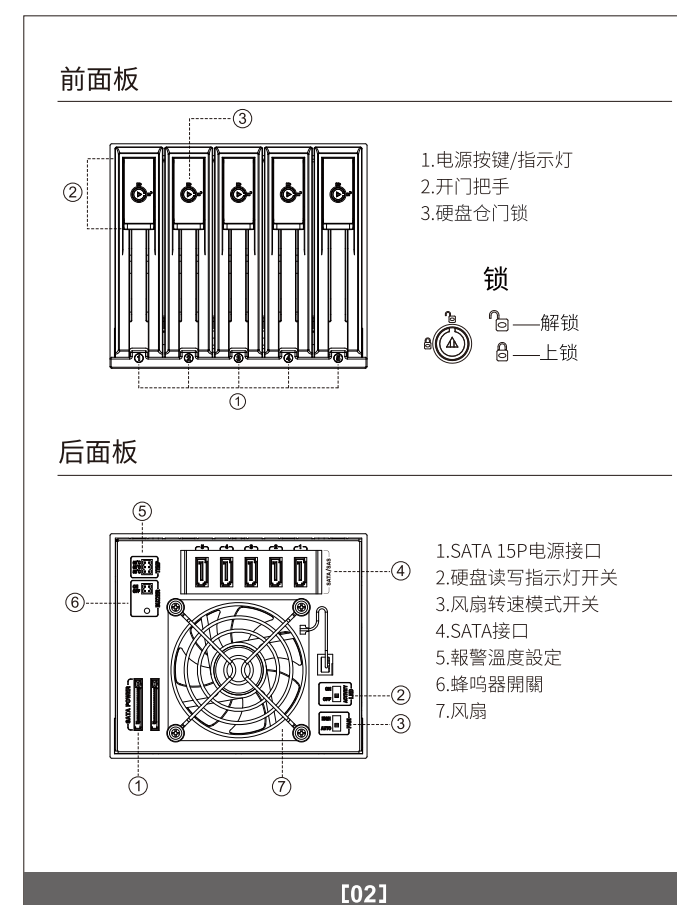

90mm 90mm

MRA505X-12G
5x3.5"SATA/SAS 12G HDD Enclosure

120mm

MRA505-12G: With power switch
MRA505N-12G: W/O power switch

说明书 | User Manual

目录
Table of Contents

中文

产品介绍 01-03
安装步骤 04
插入硬盘 05
退出硬盘 06
产品功能说明 07-08
注意事项 09

ENGLISH

Introduction 10-12
Installation 13
Inserting Hard Drive 14
Removing Hard Drive 15
How to use 16-17
Cautions 18

目录
Table of Contents

中文

产品介绍 01-03
安装步骤 04
插入硬盘 05
退出硬盘 06
产品功能说明 07-08
注意事项 09

ENGLISH

Introduction 10-12
Installation 13
Inserting Hard Drive 14
Removing Hard Drive 15
How to use 16-17
Cautions 18

Introduction

The MRA505X-12G fits five 3.5" SATA/SAS SSD/HDD in three 5.25" spaces. It can be used in harsh environments and is ideal for systems integrators and supercomputer companies who are looking for high performance and high stability of their data storage.

Specifications

- Host connector: SATA
- Supported HDD type: SATA I/II/III (6Gbps) and SAS I/II/III (12Gbps) HDD
- Material: Aluminum, SGCC, SUS430, PC
- Operating Systems: Windows/Mac
- LED indicator: Power / HDD access / Fan Failure / Temperature Alarm
- Product Dimensions: 215(L)x146(W)x127.5(H)mm
- Operating Temperature: 0 ~ 55°C

Package Content

MRA505X-12G	1 pcs
Key	2 pcs
SATA data cable	5 pcs
User manual	1 pcs
Frame screw	8 pcs

[10]

